



# DEMETER V SPECIFICATION

HBL05/180/8XX/44FR

22FR & 44FR

Excellent thermal design; uniform and consistent color; universal voltage 100-277V; LM-80 L90 LED chips; operating temp: -30°C~50°C ; different installation kit available; dimming 0-10V.

## Product data

### General Information

Light source replaceable	NO
Number of gear units	1
Driver/power unit/transformer	Power supply unit
Driver included	Yes
Optic type	Symmetrical
Optical cover/lens type	-
Luminaire light beam spread	Flood
Sensor socket	-
Cable length	Cable 0.3m without plug
Protection class IEC	-
Certifications	cETLus, FCC, DLC5.1 Premium
Lifetime (hour)	50000
EU RoHS compliant	Yes

Light source engine type	LED
--------------------------	-----

## Operating and Electrical

Input voltage	120-277V/120-347V/277-480V(12V)
Input frequency	50/60Hz
Current	1.5A(120-277V)/1.5A(120-347V)/0.7A(277-480V)
THD	<20%
Power factor (min)	0.9

## Mechanical and Housing

Housing material	Aluminum
Reflector material	-
Optical cover/lens material	PC
Optical cover/lens finish	Clear
Product dimensions mm	1113.2*405.2*63.8
Product dimensions (inch)	43.82*15.95*2.48
Product color	White

## Approval and Application

Ingress protection code	20
Mech.impact protection code	-

## Initial Performance (IEC Compliant)

Light output	24300
Luminous flux tolerance	+/-10%
Efficacy	135
Init.Corr.Color Temperature	3000K/4000K/5000K
Init.Color Rendering Index	80
Initial input power	180W
Power consumption tolerance	+/-10%

## Application Conditions

Ambient temperature range	-30°C-50°C
Dimming	0-10V

## Logistical Data

Order product name	HBL05/180/8XX/44FR
Net weight (piece)	-
Gross weight (piece)	-
Packaging dimensions (mm)	-
Packaging dimensions (inch)	-
Packaging unit (piece)	-

Volumen (m <sup>3</sup> )	-
Volumen (ft <sup>3</sup> )	-

## Application

Warehouse Lighting

Workshop Lighting

Hospital Lighting

Hotel Lighting

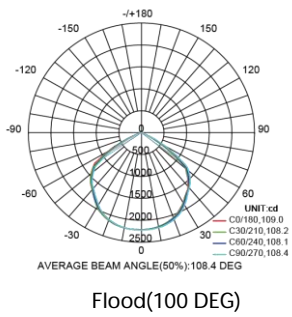

## Light Distribution & Spectrum

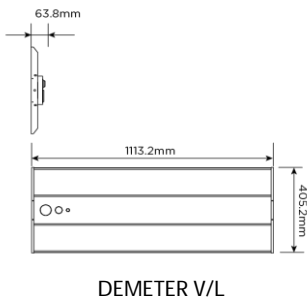

## Dimensional drawing



## Accessories

Material	Description
 Wire Guard/2	
 PIR Sensor	
 Emergency Driver	

Plusrite does not give any representation or warranty as to the accuracy or completeness of the information included herein and shall not be liable for any action in reliance thereon. The information presented in this document is not intended as any commercial offer and does not form part of any quotation or contract, unless otherwise agreed by Plusrite. Plusrite is registered.